

	Montageoppervlak
	Benodigde vrije ruimte
	Motorrail op latei

A	Dagmaathoogte	≤ 3000mm
B	Vrije bovenruimte	≥ 200mm
C	Inbouwdiepte handbediend	
E	Inbouwdiepte motorbediend	
G	Gewicht deurblad	≤ 300kg
W	Deuroppervlak	≤ 18m ²
X	Dagmaatbreedte	≤ 6000mm

C	E
2625 mm (A ≥ 1875 - ≤ 2000 mm)	3375 mm
2750 mm (A > 2000 - ≤ 2125 mm)	
2875 mm (A > 2125 - ≤ 2250 mm)	4170 mm
3000 mm (A > 2250 - ≤ 2375 mm)	
3125 mm (A > 2375 - ≤ 2500 mm)	
3250 mm (A > 2500 - ≤ 2625 mm)	
3375 mm (A > 2625 - ≤ 2750 mm)	4510 mm
3625 mm (A > 2750 - ≤ 3000 mm)	

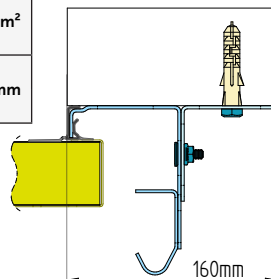

Indien de deur WK2 wordt uitgevoerd dient de benodigde zijruimte links en rechts minimaal 160mm te zijn.

C Minimaal	A + 550
E Minimaal	A + 1120
Paneeldikte	40 mm
Vrije zijruimte algemeen	85 mm
Rails onder dagmaat (A)	50 mm

	* Deurblad in de dag			
	Handbediend		Motorbediend	
X ≤ 3000	Standaard	200	Standaard	0
	Loopdeur	250	Loopdeur	50
X ≤ 4500	Standaard	210	Standaard	10
	Loopdeur	260	Loopdeur	60
X ≤ 6000	Standaard	220	Standaard	80
	Loopdeur	270	Loopdeur	80

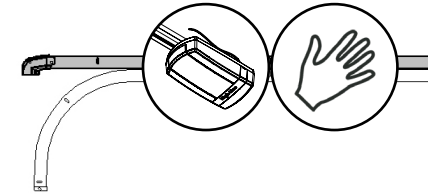
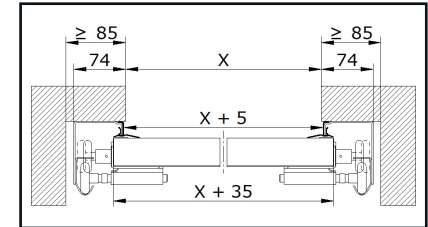
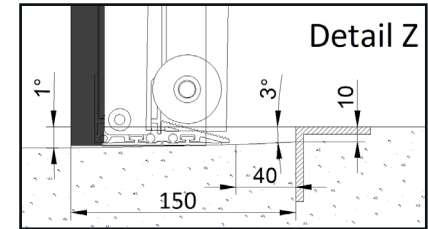
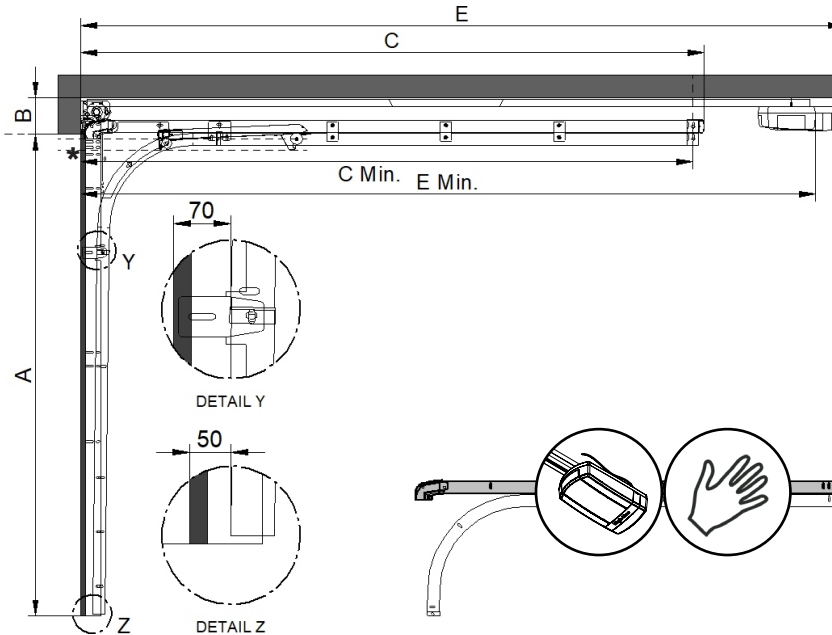
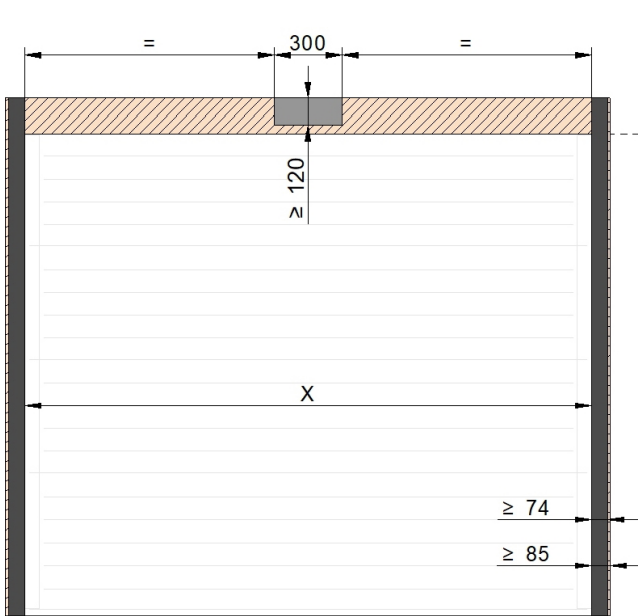

	Montageoppervlak
	Benodigde vrije ruimte
	Motorrail op latei

A	Dagmaathoogte	≤ 2500mm
B	Vrije bovenruimte	≥ 160mm
C	Inbouwdiepte handbediend	
E	Inbouwdiepte motorbediend	
G	Gewicht deurblad	≤ 165kg
W	Deuroppervlak	≤ 12,5m ²
X	Dagmaatbreedte	≤ 5000mm

C	E
2625 mm (A ≥ 1875 - ≤ 2000 mm)	3375 mm
2750 mm (A > 2000 - ≤ 2125 mm)	
2875 mm (A > 2125 - ≤ 2250 mm)	4170 mm
3000 mm (A > 2250 - ≤ 2375 mm)	
3125 mm (A > 2375 - ≤ 2500 mm)	

C Minimaal	A + 575
E Minimaal	A + 1070
Paneeldikte	40 mm
Vrije zijruimte algemeen	85 mm
Rails onder dagmaat (A)	50 mm

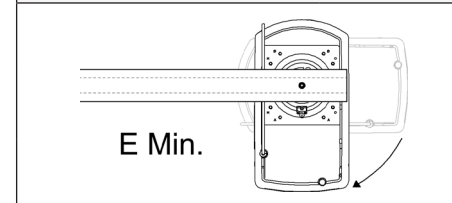

	* Deurblad in de dag			
		Handbediend		Motorbediend
X ≤ 3000	Standaard	200	Standaard	0
	Loopdeur	250	Loopdeur	50
X ≤ 4500	Standaard	210	Standaard	10
	Loopdeur	260	Loopdeur	60
X ≤ 5000	Standaard	220	Standaard	80
	Loopdeur	270	Loopdeur	80

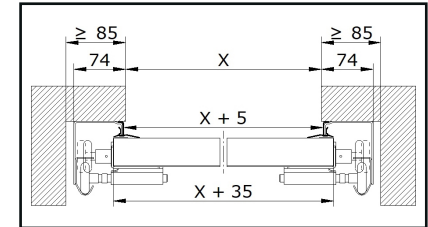
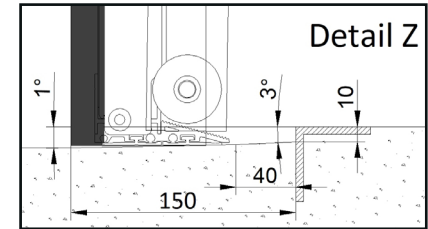
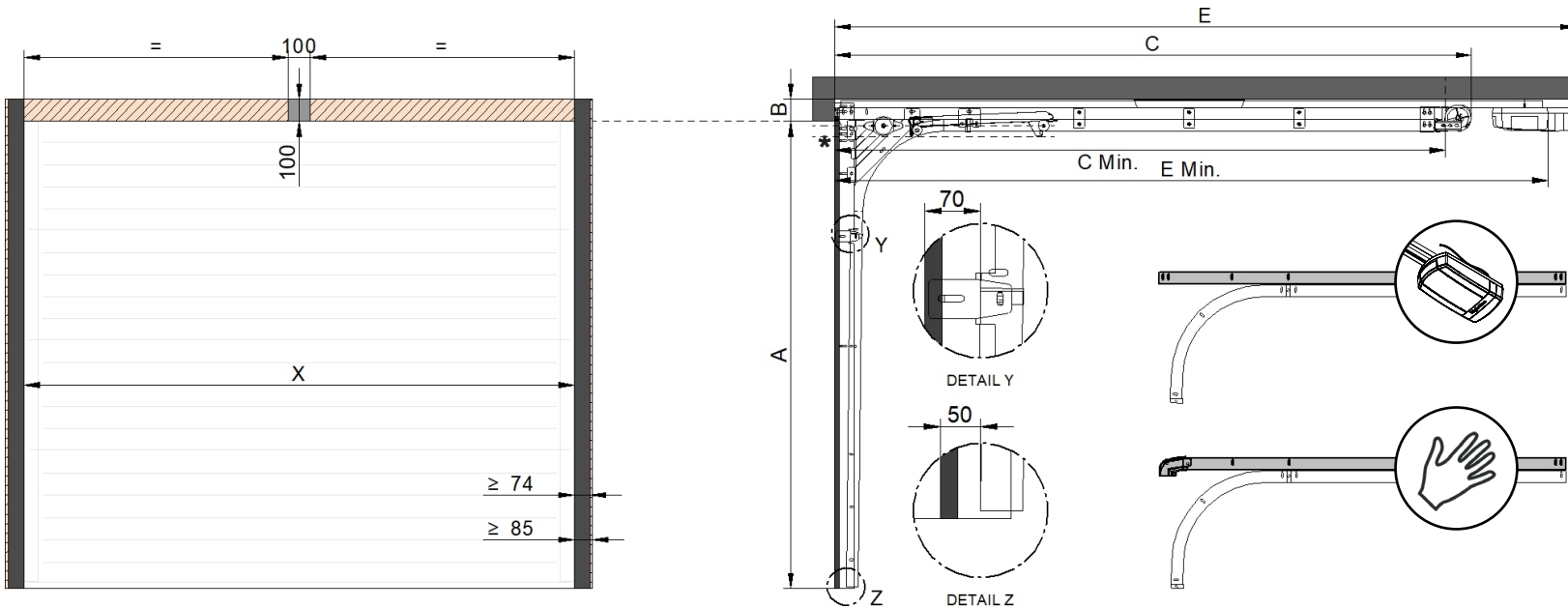

	Montageoppervlak
	Benodigde vrije ruimte
	Motorrail op latei

A	Dagmaathoogte	≤ 3250mm
B	Vrije bovenruimte	≥ 100mm
C	Inbouwdiepte handbediend	
E	Inbouwdiepte motorbediend	
G	Gewicht deurblad	≤ 300kg
W	Deuroppervlak	≤ 18m ²
X	Dagmaatbreedte	≤ 6000mm

C	E
2770 mm (A ≥ 1875 - ≤ 2000 mm)	3375 mm
2895 mm (A > 2000 - ≤ 2125 mm)	
3020 mm (A > 2125 - ≤ 2250 mm)	4170 mm
3145 mm (A > 2250 - ≤ 2375 mm)	
3270 mm (A > 2375 - ≤ 2500 mm)	
3395 mm (A > 2500 - ≤ 2625 mm)	
3520 mm (A > 2625 - ≤ 2750 mm)	4510 mm
3770 mm (A > 2750 - ≤ 3000 mm)	
4020 mm (A > 3000 - ≤ 3250 mm)	

C Minimaal	A + 650
E Minimaal	A + 1020
Paneeldikte	40 mm
Vrije zijruimte algemeen	85 mm
Rails onder dagmaat (A)	50 mm

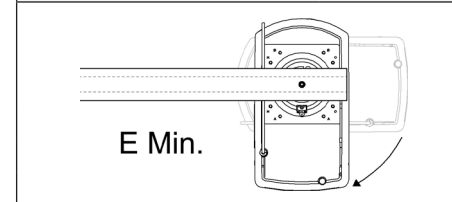

	* Deurblad in de dag			
	Handbediend	Motorbediend		
X ≤ 3000	Standaard	170	Standaard	0
	Loopdeur	220	Loopdeur	50
X ≤ 4500	Standaard	180	Standaard	10
	Loopdeur	230	Loopdeur	60
X ≤ 6000	Standaard	190	Standaard	80
	Loopdeur	240	Loopdeur	80

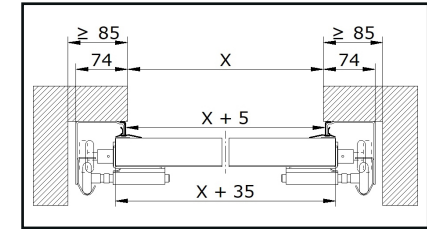
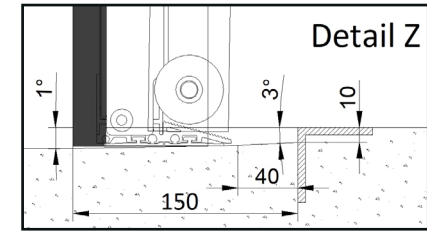
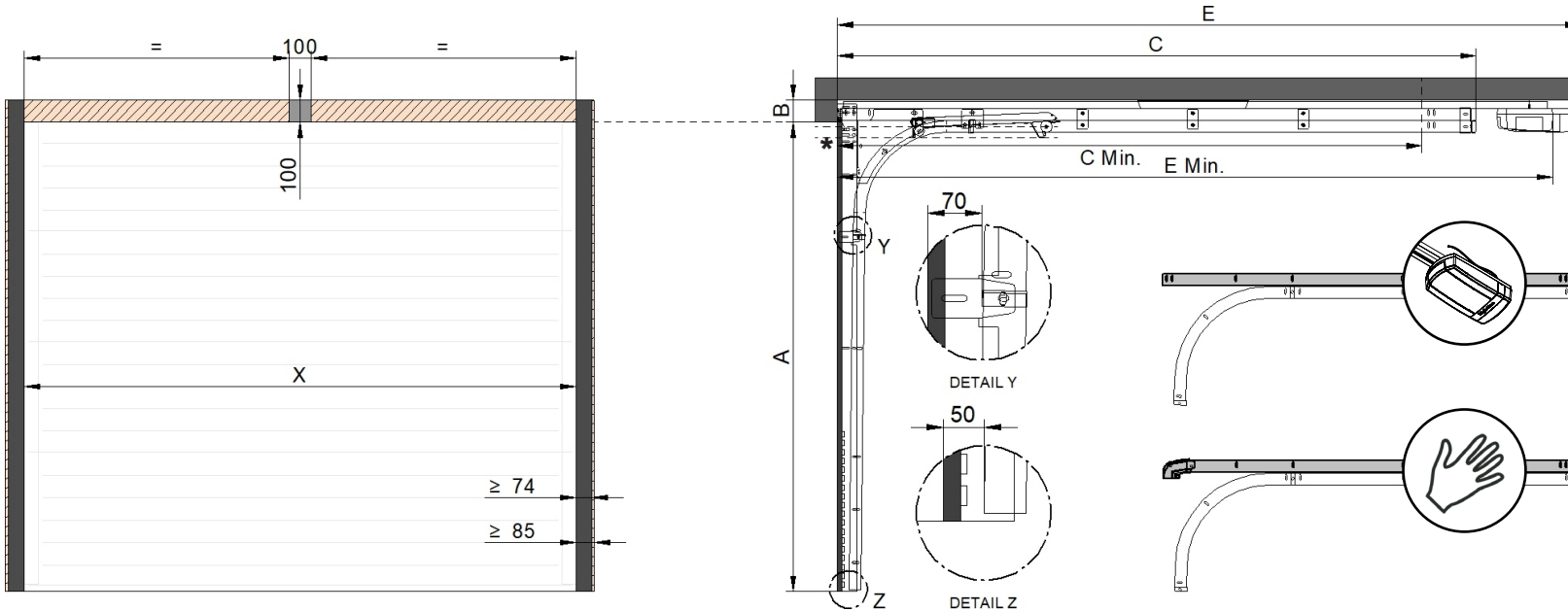

	Montageoppervlak
	Benodigde vrije ruimte
	Motorrail op latei

A	Dagmaathoogte	1875 - ≤ 3000mm
B	Vrije bovenruimte	≥ 100mm
C	Inbouwdiepte handbediend	
E	Inbouwdiepte motorbediend	
G	Gewicht deurblad	22 - ≤ 150kg
W	Deuroppervlak	≤ 12m ²
X	Dagmaatbreedte	≤ 4000mm

C	E
2770 mm (A ≥ 1875 - ≤ 2000 mm)	3375 mm
2895 mm (A > 2000 - ≤ 2125 mm)	
3020 mm (A > 2125 - ≤ 2250 mm)	4170 mm
3145 mm (A > 2250 - ≤ 2375 mm)	
3270 mm (A > 2375 - ≤ 2500 mm)	
3395 mm (A > 2500 - ≤ 2625 mm)	
3520 mm (A > 2625 - ≤ 2750 mm)	4510 mm
3625 mm (A > 2750 - ≤ 3000 mm)	

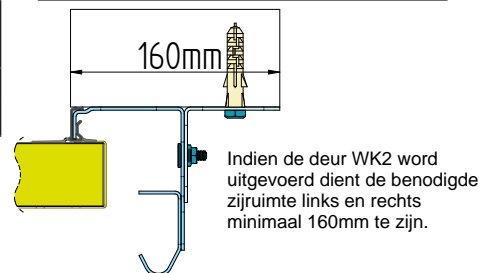

C Minimaal	A + 525
E Minimaal	A + 1020
Paneeldikte	40 mm
Vrije zijruimte algemeen	85 mm
Rails onder dagmaat (A)	50 mm

E Min.

	* Deurblad in de dag	
	Handbediend	Motorbediend
X ≤ 3000	Standaard 170	Standaard 0
	Loopdeur 220	Loopdeur 50
X ≤ 4000	Standaard 180	Standaard 10
	Loopdeur 230	Loopdeur 60

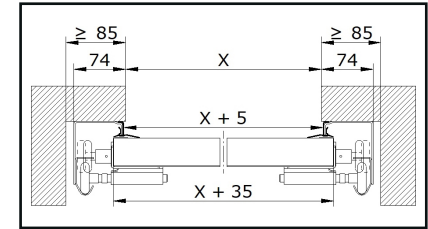
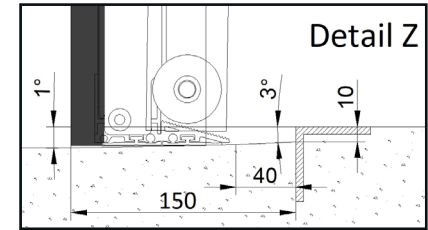
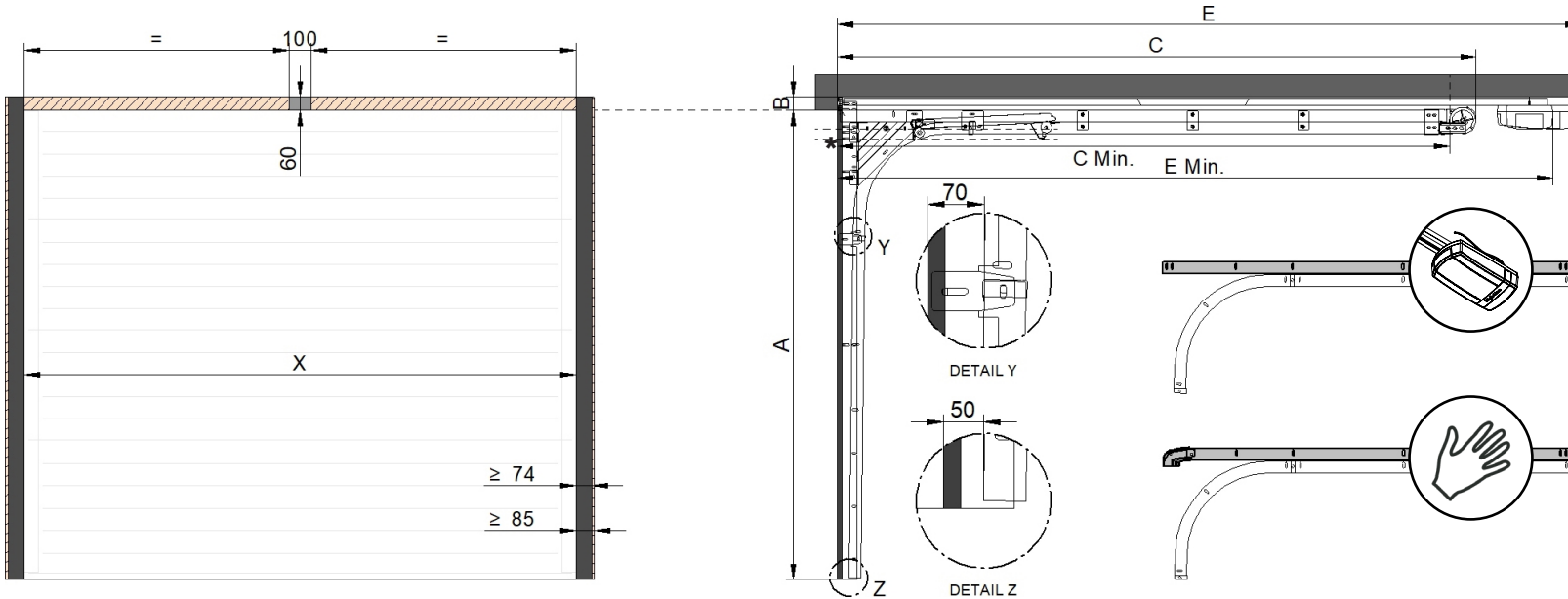

	Montageoppervlak
	Benodigde vrije ruimte
	Motorrail op latei

A	Dagmaathoogte	≤ 3250 mm
B	Vrije bovenruimte	≥ 60 mm
C	Inbouwdiepte handbediend	
E	Inbouwdiepte motorbediend	
G	Gewicht deurblad	≤ 300 kg
W	Deuroppervlak	≤ 18 m ²
X	Dagmaatbreedte	≤ 6000 mm

C	E
2770 mm ($A \geq 1875 - \leq 2000$ mm)	3375 mm
2895 mm ($A > 2000 - \leq 2125$ mm)	
3020 mm ($A > 2125 - \leq 2250$ mm)	
3145 mm ($A > 2250 - \leq 2375$ mm)	4170 mm
3270 mm ($A > 2375 - \leq 2500$ mm)	
3395 mm ($A > 2500 - \leq 2625$ mm)	
3520 mm ($A > 2625 - \leq 2750$ mm)	4510 mm
3770 mm ($A > 2750 - \leq 3000$ mm)	
4020 mm ($A > 3000 - \leq 3250$ mm)	

C Minimaal	A + 650
E Minimaal	A + 1020
Paneeldikte	40 mm
Vrije zijruimte algemeen	85 mm
Rails onder dagmaat (A)	110 mm

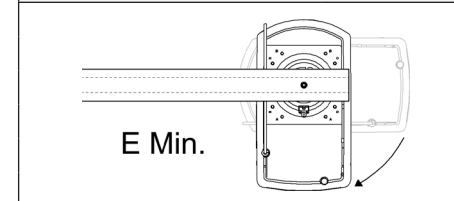

	* Deurblad in de dag			
	Handbediend		Motorbediend	
$X \leq 3000$	Standaard	230	Standaard	85
	Loopdeur	280	Loopdeur	130
$X \leq 4500$	Standaard	240	Standaard	95
	Loopdeur	290	Loopdeur	140
$X \leq 6000$	Standaard	250	Standaard	155
	Loopdeur	300	Loopdeur	155

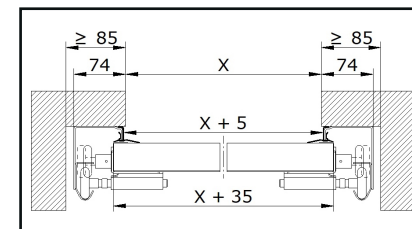
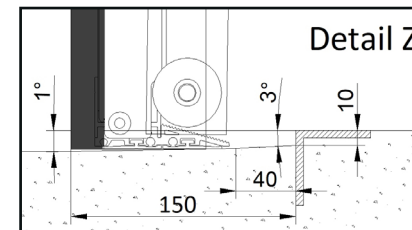
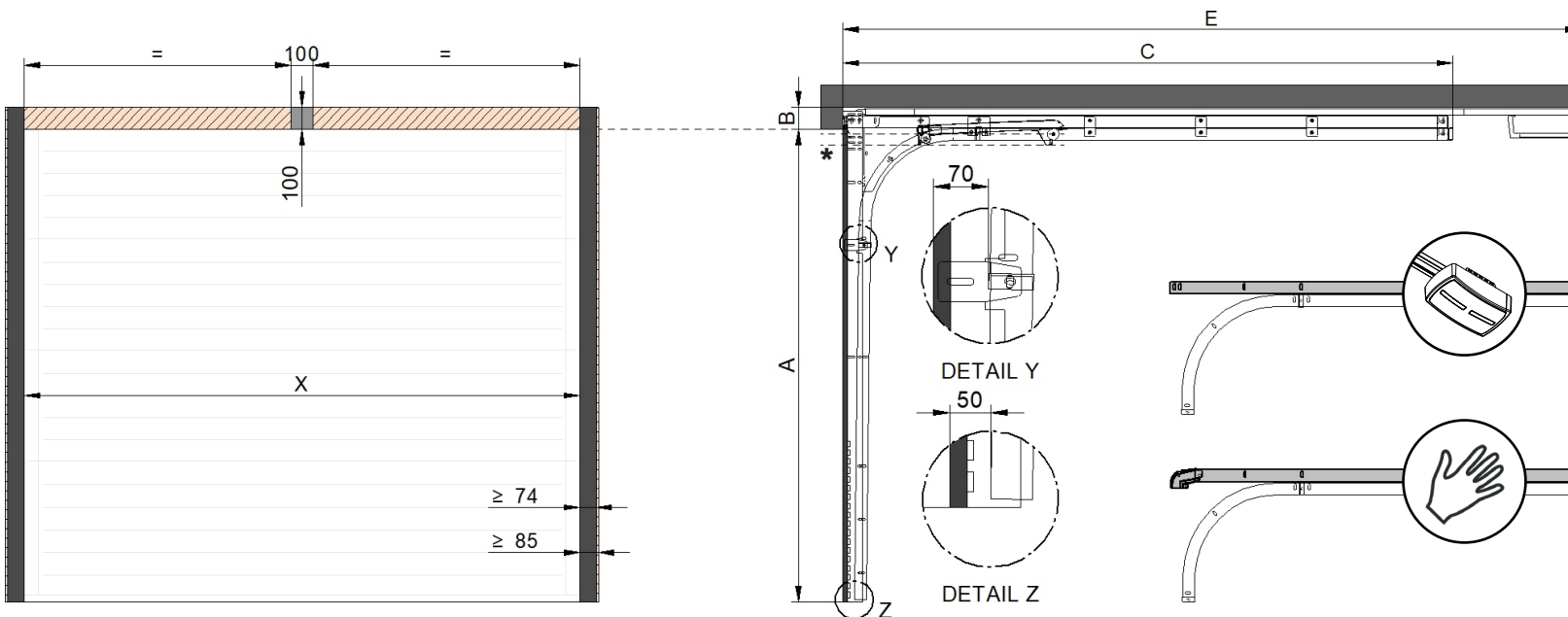

	Montageoppervlak
	Benodigde vrije ruimte
	Motorrail op latei

A	Dagmaathoogte	2000 - 2375mm
B	Vrije bovenruimte	≥ 100mm
C	Inbouwdiepte handbediend	
E	Inbouwdiepte motorbediend	
G	Gewicht deurblad	22 - ≤ 150kg
W	Deuroppervlak	≤ 12m ²
X	Dagmaatbreedte	2250 - 3250mm

C	E
2895 mm (A = 2000 mm)	3325 mm
3020 mm (A = 2125 mm)	3575 mm
3145 mm (A = 2250 mm)	3575 mm
3270 mm (A = 2375 mm)	4335 mm

C Minimaal	A + 525
E Minimaal	A + 1200
Paneeldikte	40 mm
Vrije zijruimte algemeen	85 mm
Rails onder dagmaat (A)	50 mm

	* Deurblad in de dag	
	Handbediend	Motorbediend
X ≤ 3000	Standaard	170
	Loopdeur	220
X ≤ 3250	Standaard	180
	Loopdeur	230